

Hai

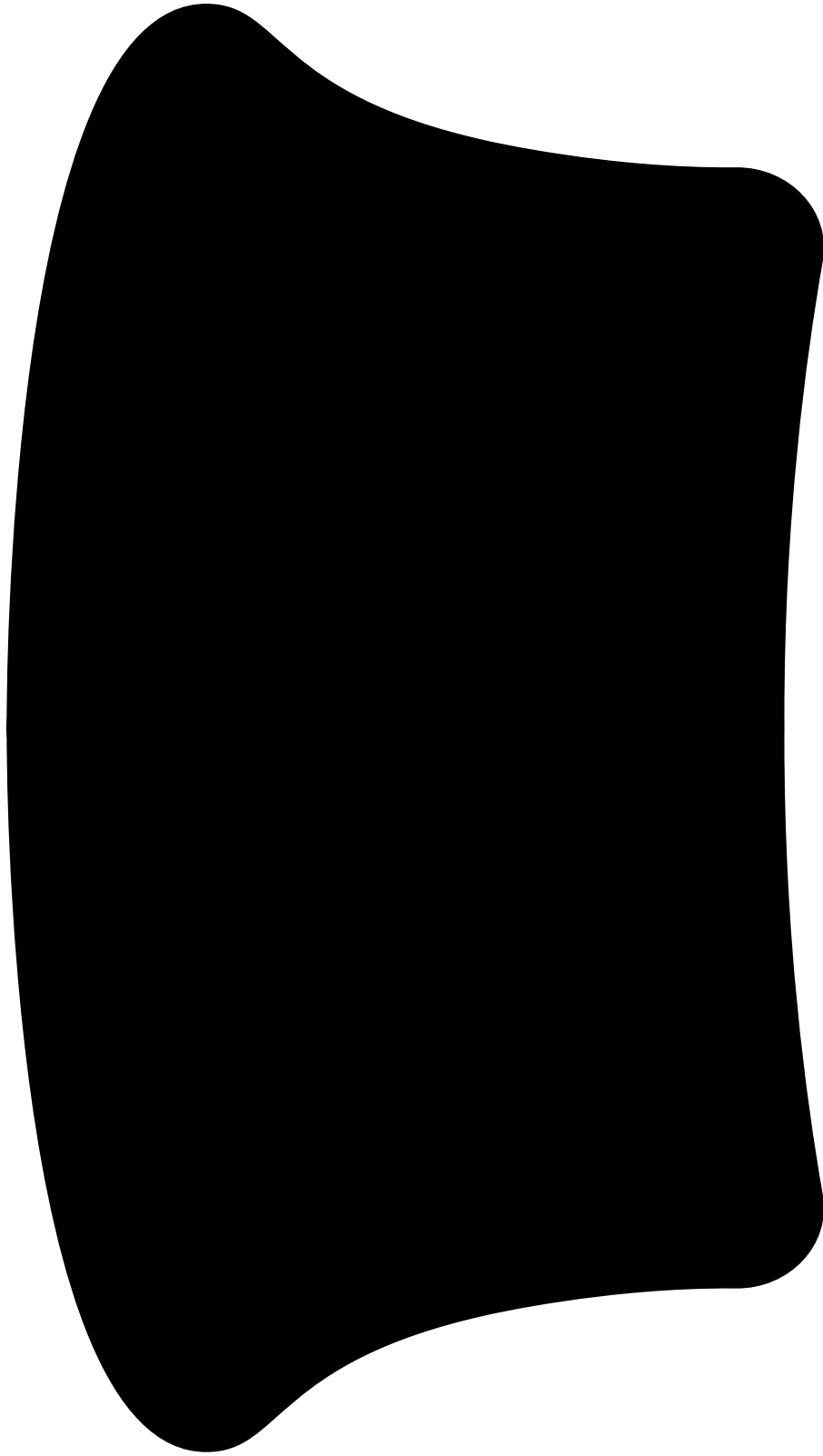

Fact Sheet









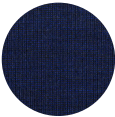
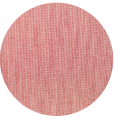
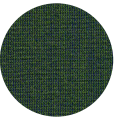

Hai Lounge Chair

Design by Luca Nichetto

The Hai Chair does everything a classic armchair does and more. Luca Nichetto's design is strong—very strong—ergonomic, and handsome, but smart about it. A lightweight metal skeleton is covered in molded foam and soft, inviting textile for maximum comfort. Although sleek and contemporary, the wide arms and high back embrace the sitter in a way that inspires total, classic relaxation. The Hai Chair's sleek looks can be admired from every angle, even from behind, making this an armchair that nobody should push into a corner.



Product name	Finish	SKU
Hai Lounge Chair	Charcoal	30558
	Eggshell	30515
	Ink	30004
	Liquorice	30151
	Melange Coral	13362
	Melange Grey	30002
	Mosaic Charcoal	10005
	Peacock	30006
	Pebble	30516
	Pink	30152
	Sawdust	30517
	Shell	30061

<p>Upholstery</p> <p><i>Uniform Mélange</i> by Febrik x Kvadrat (Netherlands) 68% New wool, 22% Nylon, 10% Polyester 100,000 Martindale Pilling 4 Lightfastness 6 Flame resistance EN 1021: Part 1 & 2, BS 5852: Part 1, US Cal. TB 117</p> <p><i>Modal Mouliné</i> by GU (Norway) 70% Virgin Wool, 30% Viscose >94,000 Martindale Pilling 4-5 Lightfastness 5-7 Flame resistance EN 1021: Part 1 & 2, US Cal. TB 117</p> <p><i>Mosaic</i> by Febrik x Kvadrat (Netherlands) 27% Wool, 9% Nylon, 12% Polyester, 6% Elasthan, 46% Polyester filling >100,000 Martindale Pilling 4-5 Lightfastness 6 Flame resistance EN 1021: Part 1 & 2, BS 5852: Part 1, US Cal. TB 117</p> <p><i>Bute Storr</i> by Bute Fabrics (Scotland) 97 % Pure New Wool, 3% Nylon 65000 Martindale Lightfastness 5 Flame resistance IMO FTP Code(2010) Annex 1, Part 8, BS 5852: Part 1 & 2 (Crib 5), US Cal. TB 121</p> <p>Leg material <i>Powder Coated Steel</i></p> <p>Inside material PU foam Steel structure</p> <p>Country of origin Poland</p>	<p>Always in stock We keep all our products in stock and ready to ship from our warehouses in the US and EU</p> <div style="display: grid; grid-template-columns: repeat(3, 1fr); gap: 10px;"> <!-- Ink --> <div style="text-align: center;">  <p>Ink <i>Uniform Mélange (0793)</i></p> </div> <!-- Pink --> <div style="text-align: center;">  <p>Pink <i>Uniform Mélange (0623)</i></p> </div> <!-- Peacock --> <div style="text-align: center;">  <p>Peacock <i>Uniform Mélange (0983)</i></p> </div> <!-- Liquorice --> <div style="text-align: center;">  <p>Liquorice <i>Uniform Mélange (0353)</i></p> </div> <!-- Shell --> <div style="text-align: center;">  <p>Shell <i>Uniform Mélange (0103)</i></p> </div> <!-- Charcoal --> <div style="text-align: center;">  <p>Charcoal <i>Uniform Mélange (0193)</i></p> </div> <!-- Charcoal --> <div style="text-align: center;">  <p>Charcoal <i>Mosaic (0182)</i></p> </div> <!-- Grey --> <div style="text-align: center;">  <p>Grey <i>Modal Mouliné (217)</i></p> </div> <!-- Coral --> <div style="text-align: center;">  <p>Coral <i>Modal Mouliné (517)</i></p> </div> <!-- Eggshell --> <div style="text-align: center;">  <p>Eggshell <i>Bute Storr Eggshell</i></p> </div> <!-- Pebble --> <div style="text-align: center;">  <p>Pebble <i>Bute Storr Pebble</i></p> </div> <!-- Sawdust --> <div style="text-align: center;">  <p>Sawdust <i>Bute Storr Sawdust</i></p> </div> <!-- Black --> <div style="text-align: center;">  <p>Black (RAL 9005) <i>Powder Coated Steel</i></p> </div> </div> <p>Samples We supply samples of all our material finishes, order them directly from hem.com/samples</p> <p>COM We offer custom upholsteries and/or stains of this product for larger orders. Reach out to info@hem.com for assistance</p>
--	---

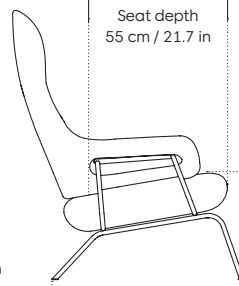
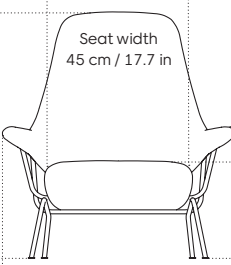
<p>Tests & certifications EN 16139:2013 – L2: Extreme use – Furniture – Strength, durability and safety – Requirements for non-domestic seating</p> <p>3D model 3D files of all products are available on the product pages on hem.com</p> <p>Product accessory Hai Ottoman</p>	Hai Lounge Chair			
	Side view	 <p>Seat depth 55 cm / 21.7 in</p> <p>39.6 cm / 15.0 in</p> <p>87 cm / 34.3 in</p>	Front view	 <p>Seat width 45 cm / 17.7 in</p> <p>100 cm / 39.4 in</p> <p>53 cm / 21.0 in</p> <p>40 cm / 15.7 in</p> <p>87 cm / 34.3 in</p>











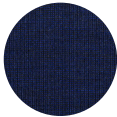

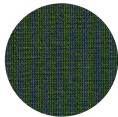
Hai Ottoman

Design by Luca Nichetto

The Hai Chair does everything a classic armchair does and more. Luca Nichetto's design is strong—very strong—ergonomic, and handsome, but smart about it. A lightweight metal skeleton is covered in molded foam and soft, inviting textile for maximum comfort. Although sleek and contemporary, the wide arms and high back embrace the sitter in a way that inspires total, classic relaxation. The Hai Chair's sleek looks can be admired from every angle, even from behind, making this an armchair that nobody should push into a corner.



Product name	Finish	SKU
Hai Ottoman	Charcoal	30559
	Eggshell	30518
	Ink	30005
	Liquorice	30153
	Melange Coral	13364
	Melange Grey	30003
	Mosaic Charcoal	10007
	Peacock	30007
	Pebble	30519
	Pink	30154
	Sawdust	30520
	Shell	30062

<p>Upholstery</p> <p><i>Uniform Mélange</i> by Febrik x Kvadrat (Netherlands) 68% New wool, 22% Nylon, 10% Polyester 100,000 Martindale Pilling 4 Lightfastness 6 Flame resistance EN 1021: Part 1 & 2, BS 5852: Part 1, US Cal. TB 117</p> <p><i>Modal Mouliné</i> by GU (Norway) 70% Virgin Wool, 30% Viscose >94,000 Martindale Pilling 4-5 Lightfastness 5-7 Flame resistance EN 1021: Part 1 & 2, US Cal. TB 117</p> <p><i>Mosaic</i> by Febrik x Kvadrat (Netherlands) 27% Wool, 9% Nylon, 12% Polyester, 6% Elasthan, 46% Polyester filling >100,000 Martindale Pilling 4-5 Lightfastness 6 Flame resistance EN 1021: Part 1 & 2, BS 5852: Part 1, US Cal. TB 117</p> <p><i>Bute Storr</i> by Bute Fabrics (Scotland) 97 % Pure New Wool, 3% Nylon 65000 Martindale Lightfastness 5 Flame resistance IMO FTP Code(2010) Annex 1, Part 8, BS 5852: Part 1 & 2 (Crib 5), US Cal. TB 121</p> <p>Leg material <i>Powder Coated Steel</i></p> <p>Inside material PU foam Wooden structure</p> <p>Country of origin Poland</p>	<p>Always in stock We keep all our products in stock and ready to ship from our warehouses in the US and EU</p> <div style="display: grid; grid-template-columns: repeat(3, 1fr); gap: 10px;"> <!-- Ink --> <div style="text-align: center;">  <p>Ink <i>Uniform Mélange (0793)</i></p> </div> <!-- Pink --> <div style="text-align: center;">  <p>Pink <i>Uniform Mélange (0623)</i></p> </div> <!-- Peacock --> <div style="text-align: center;">  <p>Peacock <i>Uniform Mélange (0983)</i></p> </div> <!-- Liquorice --> <div style="text-align: center;">  <p>Liquorice <i>Uniform Mélange (0353)</i></p> </div> <!-- Shell --> <div style="text-align: center;">  <p>Shell <i>Uniform Mélange (0103)</i></p> </div> <!-- Charcoal --> <div style="text-align: center;">  <p>Charcoal <i>Uniform Mélange (0193)</i></p> </div> <!-- Charcoal --> <div style="text-align: center;">  <p>Charcoal <i>Mosaic (0182)</i></p> </div> <!-- Grey --> <div style="text-align: center;">  <p>Grey <i>Modal Mouliné (217)</i></p> </div> <!-- Coral --> <div style="text-align: center;">  <p>Coral <i>Modal Mouliné (517)</i></p> </div> <!-- Eggshell --> <div style="text-align: center;">  <p>Eggshell <i>Bute Storr Eggshell</i></p> </div> <!-- Pebble --> <div style="text-align: center;">  <p>Pebble <i>Bute Storr Pebble</i></p> </div> <!-- Sawdust --> <div style="text-align: center;">  <p>Sawdust <i>Bute Storr Sawdust</i></p> </div> <!-- Black --> <div style="text-align: center;">  <p>Black (RAL 9005) <i>Powder Coated Steel</i></p> </div> </div> <p>Samples We supply samples of all our material finishes, order them directly from hem.com/samples</p> <p>COM We offer custom upholsteries and/or stains of this product for larger orders. Reach out to info@hem.com for assistance</p>
---	---

3D model

3D files of all products are available on the product pages on hem.com

Product accessory

Hai Lounge Chair

Hai Ottoman

Top view

52 cm / 20.3 in

40 cm / 16.0 in

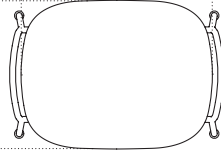

Front view

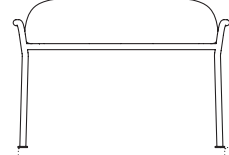

40 cm / 16.0 in

58 cm / 23.0 in

With proper care, the high quality of Hem furniture can be maintained for years to come. If you want to learn more or have any questions about our care & maintenance recommendations, please write to info@hem.com.

Hem